

For New Technology Network

NTN®



**NEW
PRODUCTS
GUIDE**

Contents

1 Bearings

1- 1 Product series for special environments	2
1- 2 Bearings with solid lubricant	2
1- 3 Angle sensor unit with high rigidity and accuracy.....	3
1- 4 Sealed self-aligning roller bearings.....	3
1- 5 Thin walled deep groove ball bearings.....	3
1- 6 Rubber/plastic molding type bearings	3
1- 7 Angular ball bearings with ceramic balls for super high speed operation	3
1- 8 Adjustable preload bearing unit	3
1- 9 LH Spherical roller bearing series.....	4
1-10 Products using HL rollers.....	4
1-11 A new series of cam followers	4
1-12 Non-separable thrust needle roller bearings.....	4
1-13 Large size, long operating life bearings (EA bearings).....	4
1-14 Long life tapered roller bearings (ECO-Top bearings)	4
1-15 Long life deep grooved ball bearings (TAB bearings)	4
1-16 Insulated bearings (Plastic coated type)	5
1-17 Thrust cylindrical roller bearings with a pressed steel cage	5
1-18 Super large-sized plummer block	5
1-19 Easy assembly/disassembly type flanges for constant velocity joints	5
1-20 Bearing units Stainless steel series	5
1-21 Bearing units Plastic series	5
1-22 Bearing units Steel series	5

2 Automotive Products

2- 1 Auto-air hub.....	6
2- 2 United arm auto-tensioner	6
2- 3 Built-in pulley auto-tensioner unit	7
2- 4 Hub bearings with integrated wheel speed sensor for ABS ...	7
2- 5 Third generation hub bearings.....	7
2- 6 Plastic pulley unit.....	7
2- 7 Needle roller bearings with a large diameter welded cage...7	
2- 8 Cageless needle roller bearings for seat slides	7
2- 9 EBJ constant velocity joints for halfshaft	8
2-10 EUJ constant velocity joint for halfshaft	8
2-11 EDJ constant velocity joint for halfshaft	8
2-12 PTJ constant velocity joint for halfshaft.....	8
2-13 HLJ constant velocity joints for propeller shafts	8
2-14 CSJ constant velocity joint for steering system	8

3 Precision Apparatus Products

3- 1 Repair unit for liquid crystal displays.....	9
3- 2 Correction unit for electrode patterns	9
3- 3 Correction/transference unit for color filters	9
3- 4 Laser beam recorder	10
3- 5 High precision XYZ positioning system	10
3- 6 Alignment type XY table	10
3- 7 Electric linear actuator	10
3- 8 Highly-rigid precision Z table	10

3- 9 Highly-rigid precision table	10
3-10 Highly-rigid precision XY table	11
3-11 Light-weight precision XY table	11
3-12 Air slide with linear motor	11
3-13 Standard air spindle (compact type)	11
3-14 Air spindle (for a mirror finish)	11
3-15 Spindles for vacuum machines	11
3-16 Air guide rollers.....	11

4 Precision Feeding Screws

4-1 High speed double thread ball screws	12
4-2 Low noise ball screws.....	12
4-3 Ball screws for electrical injection molding machine ...	13
4-4 Ball screws with high grade dustproof wiper seals ...	13
4-5 Ball screws for special environments	13
4-6 Hollow ball screws	13
4-7 Plastic sliding screws	13

5 Automation and Energy-Saving Systems Components

5-1.1 SMD feeder [for microchip resistors (R0603)]	14
5-1.2 SMD feeder [for microchip capacitors (C0603)]	14
5-2.1 SMD controller (multi-function type)	14
5-2.2 SMD controller (standard type)	14
5-3 Non-slip composite feeder	15
5-4 Spring separator feeder.....	15
5-5 Space-saving type hopper	15
5-6 Aligning unit for micro-beveled parts	15
5-7 Variable frequency controller (micro-computer type) ...	15
5-8 I/O control unit.....	15

6 Clutches

6-1 Model NCZ, One-way clutch unit	16
6-2 Model NCUX, Narrow width one-way clutch unit	17
6-3 Combined products with one-way clutches	17
6-4 Special one-way clutches	17
6-5 Torque limiter units	17
6-6 Two-way clutch unit	17

7 Sliding Bearings

7-1 BEAREE ER3000 series, sliding rubber parts	18
7-2 BEAREE PI 5000 series of thermoplastic polyimide plastics ...	18
7-3 BEAREE sliding bearings standard products	19
7-4 Sliding bearing materials for food processing machines, BEAREE FL3642	19
7-5 BEAREE seal rings/chip seals	19
7-6 Oil-impregnated sintered bearing units for high performance small motors	19
7-7 BEARPHITE SG	19

NTN

New Products Guide

1	Bearings	2 ~ 5
2	Automotive Products	6 ~ 8
3	Precision Apparatus Products	9 ~ 11
4	Precision Feeding Screws	12 ~ 13
5	Automation and Energy-Saving Systems Components	14 ~ 15
6	Clutches	16 ~ 17
7	Sliding Bearings	18 ~ 19
	NTN Catalog List	20 ~ 21
	World Network and R&D Facilities	22 ~ 25

Bearings



NTN Corporation responds to changing technologies with bearings for special environments.

1-1 Product series for special environments

NTN Corporation offers a variety of products for use in special situations: in vacuum environments, where cleanliness is an important factor, and, where corrosive elements are present. The product range includes rolling element bearings, bearing units, ball screws, sliding screws and sliding bearings.

- <Features>
- A special PTFE coating makes the line suitable for an environment demanding low dust generation, both air and vacuum.
 - When composed of plastic materials they may be used in corrosive environments.
- <Applications>
- Aerospace equipment
 - Vacuum equipment components
 - Manufacture of semiconductors
 - General industrial machinery



Cat. No. 3022/E



Solid lubricant bearings for high temperature use



Stainless steel solid lubricant bearings

NTN products contribute to a more compact application with a longer operating life.

1-2 Bearings with solid lubricant

These bearings feature a thermohardened solid lubricant, combining the unique properties of plastic and grease, that lubricates the bearing, prevents deterioration caused by moisture or dirt, adheres to the bearing components and prevents leakage.

- <Features>
- High grease retention for extended period of time.
 - Low lubricant leakage.
 - Available in full- or spot-pack: full-pack for higher speeds, spot-pack offers lower torque.
 - Operating temperature of -20°C to 120°C (100°C when in continuous operation) for high temperature type (deep groove ball bearings or bearing units).
 - Available in stainless steel series model 14: bore range 10 - 30mm (deep groove ball bearings).
- <Applications>
- Outdoor machinery, or where bearing maintenance is difficult.
 - For machinery subject to heavy vibration or centrifugal force.
 - When grease elimination must not occur (printing, food processing).



1-3 Angle sensor unit with high rigidity and accuracy

These angle sensor units are highly accurate and offer satisfactory load capacity and water resistance. The units incorporate new technologies for bearings and potentiometers.

- <Features>
- High rigidity which accepts 100 G impact loads.
 - High accuracy with a single linearity within $\pm 0.5\%$.
 - The units cleared the water resistance test; JIS D 02023.
- <Applications>
- For machinery used in demanding environments, such as construction machinery.



Cat. No. 3702/E

1-4 Sealed self-aligning roller bearings

Favored by many industries for their large load capacity and multipurpose characteristics, this compactly designed, sealed self-aligning roller bearing has been developed to allow longer servicing intervals in dusty environments and to extend lubrication intervals.

- <Features>
- Effectively prevents infiltration of foreign matter.
 - Bearings can be assembled with a standard plummer block.
 - Greasing is possible even though the bearings are enclosed.
- <Applications>
- For raw material transfer conveyors at steel mills, cement factories, thermal power stations and mines.



Cat. No. 3102/E

1-5 Thin walled deep groove ball bearings

The deep groove ball bearing series has been expanded to add the 67 series. Compact and light weight, the thin wall 67 (6700 - 6706) series design extends the 68 series deep groove ball bearings.

- <Features>
- Thinner wall than the 68 series.
 - NTN provides a non-contact seal type (LLF) in addition to the open type.
 - The dimension accuracy meets JIS Class 0 requirements.



1-6 Rubber/plastic molding type bearings

Urethane rubber is formed and cemented to the bearing's outside diameter; or, polyacetal or polyethylene plastic is molded or pressed directly to the bearing. Rubber and plastic molded bearings provide high accuracy, low vibration and low noise.

- <Features>
- Outer diameter oscillation highly controlled, making correct feeding possible.
 - Plastic molding type can be designed to various external shapes.
- <Applications>
- Used in ATM and money changing machines' recognition and transfer (bills/cards) mechanisms.
 - For recognition and transfer mechanisms of automatic vending machines.
 - For transfer machine guide rings.



1-7 Angular ball bearings with ceramic balls for super high speed operation

These bearings present the super high revolution dn value, 2,100,000 (as dmm value; 2,600,000) using air-oil lubrication. Boundary dimensions are equal to the previous HSB series, but super high speed revolution using air-oil lubrication can be obtained. Bearings also operate under high acceleration conditions.

- <Features>
- The special design reduces the temperature rise and maintains its rigidity.
 - Temperature rise in the inner ring is about 10°C lower than in other NTN products.
 - Bearings also operate under high acceleration conditions (only 3 seconds to reach dn 2,100,000).
- <Applications>
- Machining tool spindles.



1-8 Adjustable preload bearing unit

Compact design of bearing units make high speed and rigidity possible. Pressurizing loads on the bearing can be changed in two to three steps according to the spindle rotation speed. It is possible to select a heavy-loading mode in the slow speed range, and the most suitable shaft rigidity for light-pressurizing and machining conditions in the high speed range. The grooved shaft design solved the rise of pressurization due to the compact design of the spindle and the expansion of the bearing inner ring at high speed revolutions.

- <Features>
- Constant position pressurization system with high rigidity.
 - Compact design of spindle and good heat tolerance.
- <Applications>
- Suitable for spindles of various precision machining tools.



Cat. No. 3027/E

1-9 LH Spherical roller bearing series

Operable in a wider temperature range from normal temperature to higher temperatures (250°C).

- <Features>
- Longer bearing life at normal to higher temperatures.
 - Highly resistant to surface damage.
 - Better dimensional stability at higher temperature.
 - More resistant to fatigue crack.

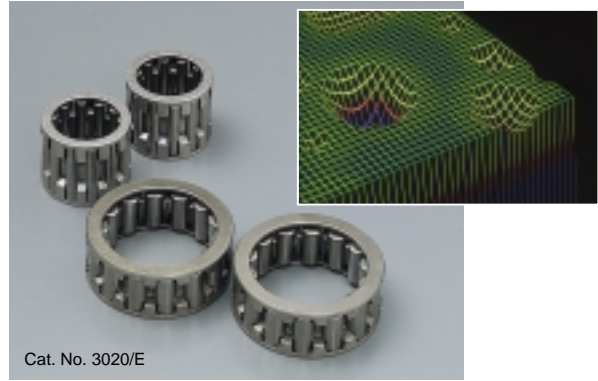

Cat. No. 3020/E

1-10 Products using HL rollers

The micro oil pot effect, based on the EHL theory, allows a longer operating life.

- <Features>
- The improvement of rolling surface shape based on the micro EHL theory increases the oil film formation ability.
 - These bearings have longer operating lives than previous products, even under severe conditions.
 - Applicable not only to the rolling body (rollers) of bearings but also to the external circumference of guide roller outer rings.



1-11 A new series of cam followers

A broad line of cam followers for any condition is now available.

- <Features>
- The cam followers with top holes (top holes for grease nipples located at stud ends) allow unrestricted maintenance access.
 - The 0.5 - 2mm eccentric rate of the stud on the shaft eccentric cam follower allows for easy installation and adjustment.
 - The compact design and high precision guide roller of the mini-size cam follower has a stud diameter of 3 - 5mm and an outer ring of 10 - 13mm



1-12 Non-separable thrust needle roller bearings

A thrust needle roller and cage assembly and a pressed steel bearing ring are integrated into a non-separable compact easy-to-handle bearing unit.

- <Features>
- Inseparable cage-ring combination allows easy handling (simpler assembly work).
 - No need for grinding of a companion component ensures VA.
 - Optional special bearing ring design can enhance the amount of oil flowing through the bearing and provide error free bearing assembly work.



1-14 Long life tapered roller bearings (ECO-Top bearings)



1-15 Long life deep groove ball bearings (TAB bearings)

1-13 Large size, long operating life bearings (EA bearings)

These bearings will achieve longer life even when the lubricant is contaminated. Developed using new technologies, these bearings significantly improve bearing operating life in dirty applications such as steel rolling mills and automotive transmissions. EA bearings are available in tapered, cylindrical and self-aligning roller bearings. ETA bearings are tapered roller bearings and TAB bearings are deep groove ball bearings.

- <Features>
- Special carbonization and nitriding treatments offer longer operating life.
 - Operating life exceeds standard bearing life: performs more than twice as long in clean lubricant conditions and more than 5 times longer when lubricant is contaminated.
- <Applications>
- Automotive transmissions, where lubricant may experience contamination.
 - Steel rolling and casting equipment subject to poor lubrication, vibration and frequent impact.



Cat. No. 3204/E

1-16 Insulated bearings (Plastic coated type)

Designed to prevent electrolytic corrosion, these bearings provide a long operating life. The insulating plastic coating (special PPS plastic) of the outer surface and side faces of the outer ring protect the bearing from external stray currents and prevent the electrolytic corrosion that frequently occurs on the main motor bearings of railway cars.

- <Features>
- High insulation.
 - Compatible use with standard bearings.
- <Applications>
- For motor bearings and where the prevention of stray current flowing through the bearing is difficult.



Cat. No. 2300/E

1-17 Thrust cylindrical roller bearings with a pressed steel cage

The pressed steel cage is an economical choice for this thrust cylindrical roller bearing.

- <Features>
- In comparison with standard bearings with an aluminum machined cage, the steel cage material is cheap and suitable for mass production.
 - The material, steel plate, permits various heat treatments and surface processes.
 - The wall thickness may be thinned, to stem width, allowing improved capacity ratings of the same dimension.

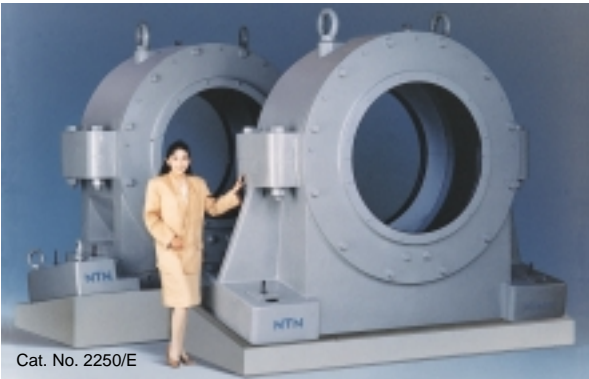

Cat. No. 2250/E

1-18 Super large-sized plummer block

This super large-sized plummer block (height of 2,150mm) is used to retain the tube dryer unit in steel mills.

- <Boundary dimensions> 2,150 x 2,750 x 1,100 mm
- <Bearing used> 240/1180BK30



Cat. No. 5603/E

1-19 Easy assembly/disassembly type flanges for constant velocity joints

The flange's design makes it easy and simple to connect and disconnect the joint — even tools are unnecessary — and it operates smoothly.

(Applied joint model numbers: #75 - #150)



Cat. No. 3903/E

1-20 Bearing units Stainless steel series

These stainless steel bearing units provide excellent corrosion resistance.

- <Features>
- The units combine a stainless steel housing and a stainless steel bearing with solid lubricant.
 - Excellent corrosion resistance.
 - Low lubricant leakage.
 - Small rotation torque.
- <Applications>
- Food processing machines.
 - Packaging machines.
 - Textile machines.

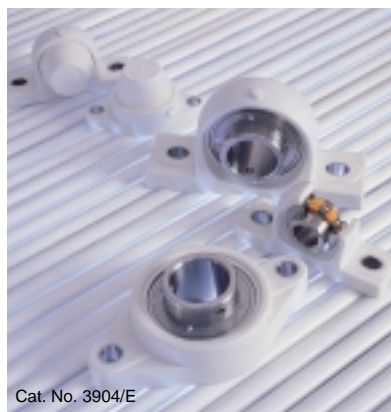

Cat. No. 3904/E

1-21 Bearing units Plastic series

Light-weight bearing units with excellent corrosion resistance and chemical resistance.

- <Features>
- The units combine a plastic housing and a stainless steel bearing with solid lubricant.
 - Light weight (30 to 60% lighter than cast iron products from NTN).
 - Excellent water and corrosion resistance.
 - Low lubricant leakage.
 - Small rotation torque.
- <Applications>
- Chemical machines
 - Food processing machines.
 - Packaging machines.



Cat. No. 3902/E

1-22 Bearing units Steel series

The steel housings provide rigidity, high load capacity and impact resistance.

- <Features>
- Rolled steel (SS400) is used for the general structure of the housing.
 - Excellent impact resistance.
 - Greater rigidity than with previous cast steel products.
 - Insert bearing fits various housing types.
- <Applications>
- Steel industry equipment.
 - Conveyors, trucks, etc.

Automotive Products



Pneumatic operation for smooth-switching.

2-1 Auto-air hub

- <Features>
- An air-hub actuated by a pneumatic system, it uses the engine's negative pressure to change between 2WD and 4WD from the operator's seat.
 - Adoption of a new pneumatic mechanism which operates only while changing between 2WD and 4WD.

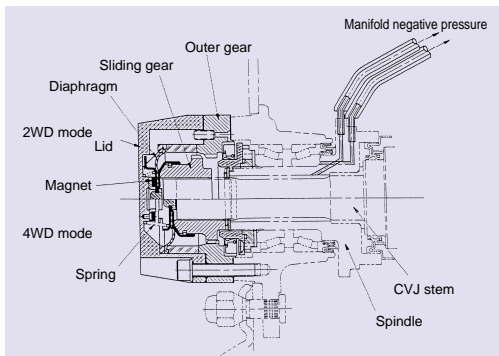

Structure of automatic air-hubs

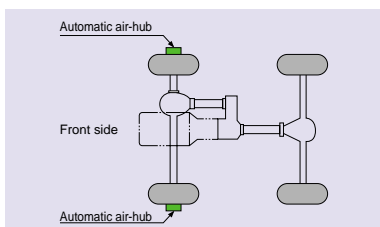

Locations equipped with automatic air-hubs



United auto-tensioner and pulley.

2-2 United arm auto-tensioner

- <Features>
- Entire unit swings, centering around the axis with one fixed point to adjust belt tension.
 - Compared to previous separated types, these products present a light weight, compact design and low cost.

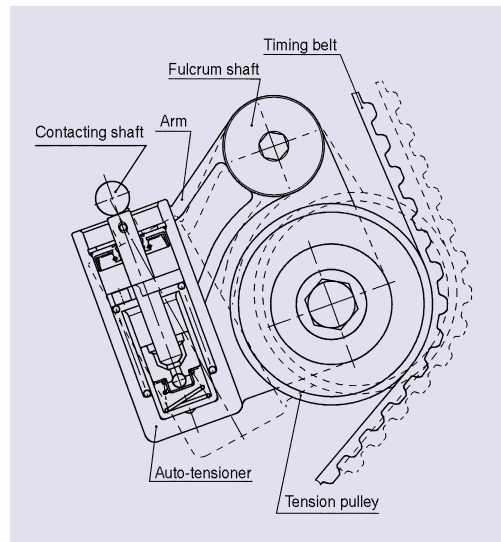

Action of the united arm auto-tensioner



2-3 Built-in pulley auto-tensioner unit

Super small type which unites the auto-tensioner and pulley.

- <Features>
- The swing fulcrum and mounting bolts are installed inside the pulley bore diameter.
 - The micro hydraulic auto-tensioner is installed inside the pulley bore diameter to unite the pulley mechanism.



2-4 Hub bearings with integrated wheel speed sensor for ABS

The ABS sensor is installed in the hub-type axle bearing.

- <Features>
- The structure prevents damage from external causes by installing the ABS sensor inside the shaft.
 - The installation of sensor reduces the assembly process at automobile manufacturing plants and increases reliability.



2-5 Third generation hub bearings

The hub and mounting flange are united with the bearing.

- <Features>
- The integration of the bearing inner ring and hub, also, the integration of the outer ring and knuckle allows the hub bearing to fix to the knuckle using bolts, which reduces the assembly processes.
 - Compact design along the axial direction by the integration of the bearing inner ring and hub.
 - The follower ring needs no clearance control post-assembly. The drive ring controls clearance after assembly only by adjusting the fastening torque control to the drive shaft nut.

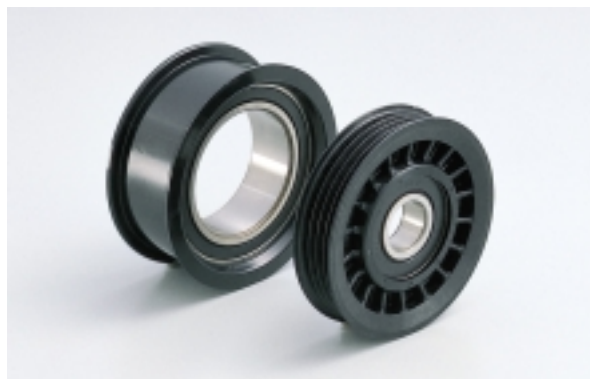

2-6 Plastic pulley unit

Adoption of the plastic pulley unit makes the design lightweight and reduces the cost.

- <Features>
- The use of the plastic in the pulley design allows the option of ribs or grooves in a wide range of figures.
 - The design reduces the weight and cost.



2-7 Needle roller bearings with a large diameter welded cage

This newly developed welded cage contributes VA of big vehicles.

- <Features>
- Cage strength is increased as the plate used is thicker than with previous welded cages.
 - Bearings have a stable face guide and roller-holding ability.
 - Bearings may be produced up to a possible inscribed circle diameter of 100mm, which reduces costs.



2-8 Cageless needle roller bearings for seat slides

Designed especially for seat slides, these needle roller bearings focus on cost and reliability.

- <Features>
- The outer ring is manufactured from pressed steel for a lower cost bearing.
 - Thick steel plate is adopted for outer rings in order to use the outer ring outside diameter directly as a rolling face.
 - To avoid the interference with other parts, the chamfer of circumference on the pressed outer ring is made smaller by the new press machining.

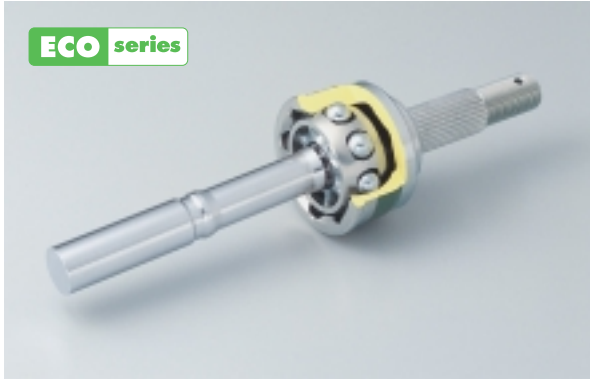

2-9 EBJ constant velocity joints for halfshaft

Compact and highly efficient fixed type constant velocity joints

<Features>

- New design reflects improved specification involving balls of smaller size in increased number.
- More compact outside diameter.
- Improved transmission efficiency (lower fuel consumption)



2-10 EUJ constant velocity joint for halfshaft

High performance, compact fixed type constant velocity joint capable of greater operating angle.

<Features>

- New design reflects improved specification involving balls of smaller size in increased number.
- Maximum operating angle of 50°.
- More compact outside diameter.
- Improved transmission efficiency (lower fuel consumption)



2-11 EDJ constant velocity joint for halfshaft

High performance, compact plunging type constant velocity joint.

<Features>

- New design reflects improved specification involving balls of smaller size in increased number.
- More compact outside diameter.
- Improved transmission efficiency (lower fuel consumption)



2-12 PTJ constant velocity joint for halfshaft

plunging type constant velocity joint with low, stable vibration characteristics.

<Features>

- 3rd order component of induced cyclic axial load which greatly affect the vibration characteristics of automobiles, have been positively reduced.
- Low, stable vibration characteristics regardless of operating angle.



2-13 HLJ constant velocity joints for propeller shafts

Special constant velocity universal joints for propellers are suitable for high speed rotation

<Features>

- Products are developed especially for propeller shafts based on the LJ (cross groove joints) model.
- Low temperature rise during operation allows the joint to accept high speed revolutions.
- Improved slide resistance and folding torque increases the anti/low vibration characteristics.
- Compact and lightweight.



2-14 CSJ constant velocity joint for steering system

Fixed type constant velocity joint optimized for steering system.

<Features>

- Minimum play in the rotating direction, as well as smooth operation.
- One constant velocity joint unit alone helps design simple steering system.
- Maximum allowable operating angle of 40°.

Precision Apparatus Products

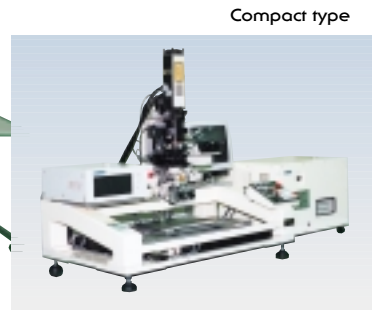

Easy operation allows more accurate repair of liquid crystal display.

3-1 Repair unit for liquid crystal displays

For more efficient correction and machining of defective places (pixels) in the liquid crystal display.....

- <Features>
- The Q-switch installed YAG laser sharply cuts the thin film of liquid crystal panels and masks.
 - The laser power and its emitting pattern are easily controlled by the electrically operated mechanism showing on the monitor screen.
 - There are various types from the compact type (with an effective stroke of 340x240mm) to the long stroke type (with an effective stroke of 700x700 mm) according to the work size and applications.

The open/short defects of the electrode pattern can be corrected.

3-2 Correction unit for electrode patterns

The paste application mechanism for minute area and the YAG laser emission system are equipped to correct defects of various displays.

- <Features>
- Automated open-defects correction system from the application to sintering.
 - The YAG laser can be mounted with an appropriate wave length according to the material.
 - Rich optional settings are available such as image processing equipment.

Correction of black and white defects of color filters for liquid crystal displays.

3-3 Correction/transference unit for color filters

The correction tape with uniform film thickness is thermal-transferred to the defective part of the color filter to correct the defect.

- <Features>
- The unit corrects the white defect so that it becomes almost the same color and film thickness as the surrounding area.
 - It is possible to install the YAG laser suitable to the color filter cutting for correction of black defects.
 - Optional settings are available such as the automated defect correction, UV exposure function and image processing function.





3-4 Laser beam recorder

The unit exposes and draws the master disc of optical discs such as CDs and DVDs by using a laser.

- <Features>
- Moving parts are completely non-contact and highly accurate.
 - Sending system using the length measurement by laser and the linear motor drive presents the high accuracy of $\pm 0.01 \mu\text{m}$.
 - Rotating system uses the PLL control providing super low jitter.

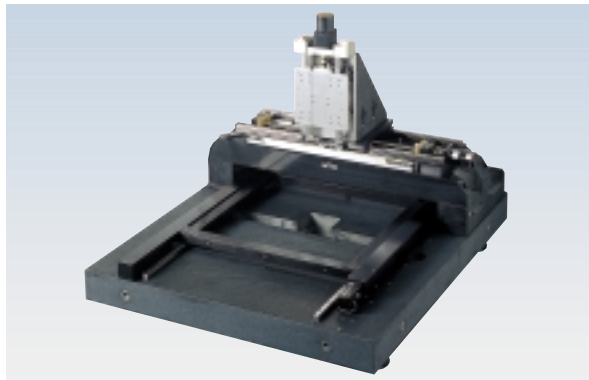

3-5 High precision XYZ positioning system

Highly accurate positioning system adopting the granite for main structural materials.

- <Features>
- No change by time passing, and high rigidity as well as high attenuation.
 - The system adopts the closed loop control method by using the linear scale to provide high accuracy as well as the granite gate shape structure.
- <Applications>
- Machining and examination equipment related to semiconductor and liquid crystal plants.
 - Precision measurement equipment.

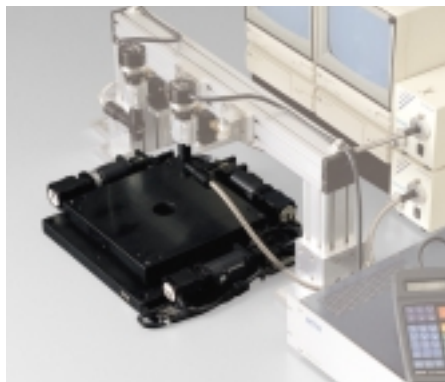

3-6 Alignment type XY table

High precision positioning table using electric linear actuators.

- <Features>
- The table has a high loading capacity and rigidity with super thin and simple structure.
 - Precision rotating and linear positioning is possible.
 - The rotation center can be set at any position.
 - The structure has a central penetration hole.
- <Applications>
- Screen printing machines.
 - Liquid crystal panels, printed circuit board production and test units.
 - Semiconductor production and test units.
 - Application to the super thin table.



3-7 Electric linear actuator

Small but highly accurate and powerful linear actuator with the sensor installed.

- <Features>
- Repeating positioning accuracy: $\pm 1 \mu\text{m}$
 - Lost motion: $1 \mu\text{m}$
 - High thrust: 169 - 369N
 - \pm Limit sensors are installed.

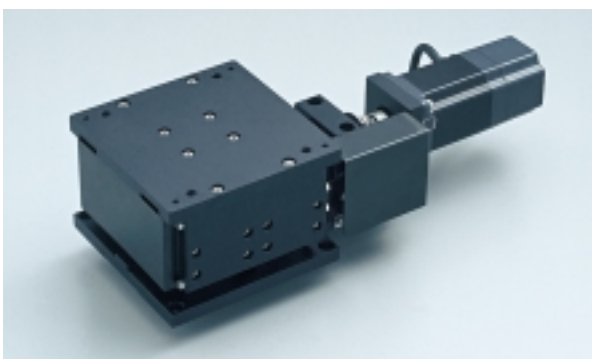

3-8 Highly-rigid precision Z table

Wedge mechanism helps achieve greater thrust and higher rigidity.

- <Features>
- Wedge mechanism complete with a reducing function has led to a thin, highly-rigid precision table.
 - Horizontal installation of motor helps design the thinner table.
 - Combination of linear guide and ball screw contributes to greater rigidity and higher precision.
 - Capable of coordination with XY, XY and tables.
 - According to a particular application requirement, the drive motor may be a stepping motor or servo motor.
- <Applications>
- Manufacturing and inspection equipment for semiconductor devices and flat panel display
 - Manufacturing and inspection equipment for PCB

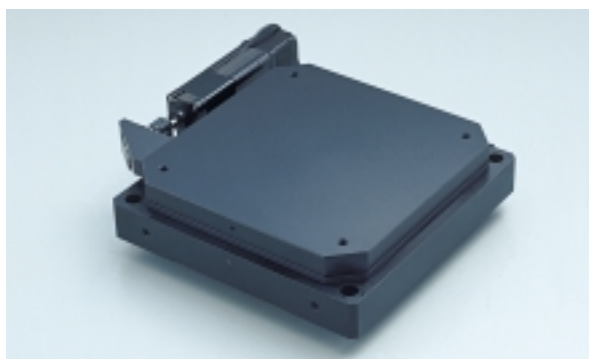

3-9 Highly-rigid precision table

High precision table incorporating electric linear actuator.

- <Features>
- Capable of carrying a greater load, featuring higher rigidity, in spite of thin, simple construction.
 - Rotary positioning of higher precision.
- <Applications>
- Manufacturing and inspection equipment for semiconductor devices and flat panel display
 - Manufacturing and inspection equipment for PCB

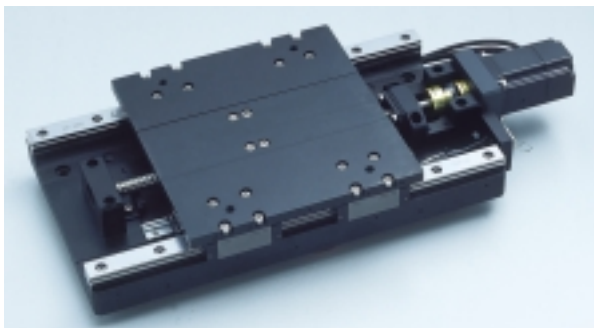

3-10 Highly-rigid precision XY table

High-rigidity and high-precision XY table made of cast iron, capable of integration with Z and tables.

- <Features>
- Cast iron frame ensures a thin design that withstands greater loading.
 - Combination of linear guide and ball screw contributes to greater rigidity and higher precision.
 - XY table can be configured by stacking up two 1-axis tables.
 - Can be combined with high-rigidity and high-precision Z or table.
 - A wide range of product line (base width, stroke) can cope with a variety of applications.
 - According to a particular application requirement, the drive motor may be a stepping motor or servo motor.
 - Full closed loop control scheme using linear scale can be incorporated.
 - Positive dust-proofing measure can be incorporated with a bellows cover.
- <Applications>
- Manufacturing and inspection equipment for semiconductor devices and flat panel display.
 - Auto assembler machines.
 - Precision machine tools.

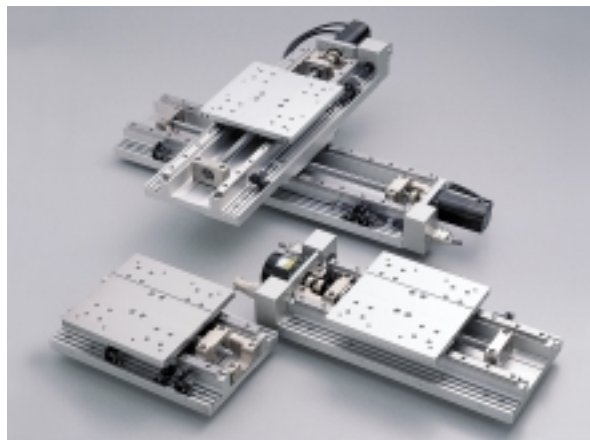

3-11 Light-weight precision XY table

Precision table exclusively made of aluminum components is delivered to users promptly.

- <Features>
- Combination of linear guide and ball screw contributes to greater rigidity and higher precision.
 - XY table can be configured by stacking up two 1-axis tables.
 - According to a particular application requirement, the drive motor may be a stepping motor or servo motor.

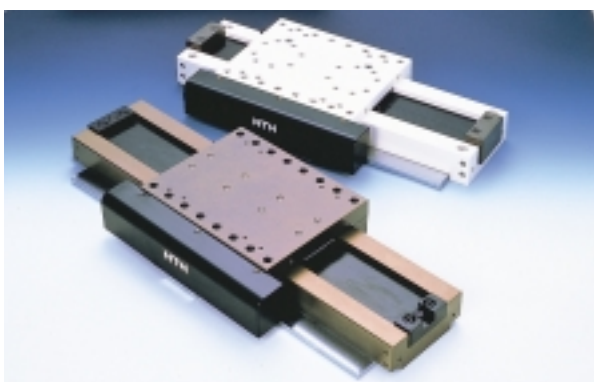

3-12 Air slide with linear motor

Completely non-contact drive air slide installed with a linear motor.

- <Features>
- The hybrid structure of magnets and static air bearings allows for a thin design.
 - Since the rotal face of the guide touches the ground, the straightness rate is improved.
- <Applications>
- Precision measurement instruments, precision test units and semiconductor production facilities.



3-13 Standard air spindle (compact type)

High-precision, high-speed compact air spindle-much smaller than conventional models, but capable of 20,000 rpm.

- <Features>
- Highly accurate non-repetitive runout (NRRO: 0.02 μm max.)
 - Low air consumption, and economical.
- <Applications>
- Hard disk inspection equipment.
 - CD/DVD inspection equipment.
 - Hard disk floatation inspection equipment.



3-14 Air spindle (for a mirror finish)

This air spindle performs superior precision machining. The sub micron roundness and area accuracy can be manufactured by machine cutting.

- <Features>
- Highly accurate non-repetitive runout (NRRO: 0.03 μm)
 - Change of the shaft axis is small.
 - Precision machining is possible.

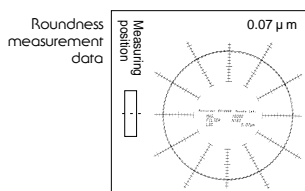

3-15 Spindles for vacuum machines

Compatible type with the position detecting controller installed inside the spindle. The adjustment of magnetic bearing control circuit is possible for the spindle and controller by installing the position detecting controller in the spindle, which was previously installed on the controller side.

- <Features>
- Since there is no mechanical contact, the rotation is quiet, makes low vibration and is resistant to high speed revolution for a long operating life.
 - There is no environmental pollution since lubricant is unnecessary.
- <Applications>
- Spindles for the turbo molecular pumps.
 - Spindles for blowers of various gases.



3-16 Air guide rollers

Perfect non-contact guide roller by using pneumatic bearing supports.

- <Features>
- Low torque, uneven low torque
 - Long operating life
 - Easy maintenance
 - Low air consumption
- <Applications>
- Manufacturing equipment of optical Tapes, films, fibers

Precision Feeding Screws

For simultaneous high speed feeding and large load capacity.

4-1 High speed double thread ball screws

- <Features>
- High speed feeding is possible by the high-leads design.
 - Double thread enables the screw to have a large load capacity.
 - The high positioning accuracy is held by pressurization.
 - The high-leads design also advantageously reduces the noise and temperature rise in comparison with the single thread screw.



A special soundproof structure provides low noise screws.

4-2 Low noise ball screws

The soundproof structure of the nut's outer circumference face reduces the maximum noise by 14 dBA (compared with other NTN products).

- <Features>
- Ball circulating sound is low.
 - The ball rolling sound is low due to a special finish to the ball rolling raceway on the screw axis.
 - Compatible with previous products since the related dimensions of the nuts are the same as previous models.

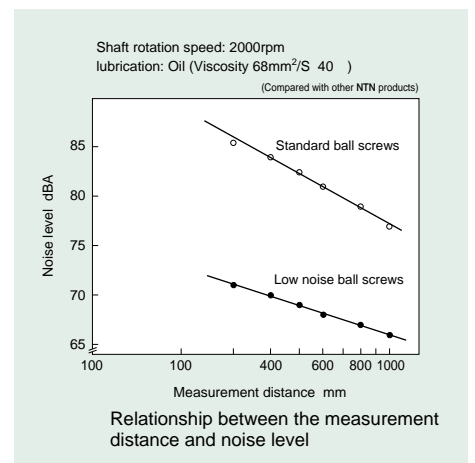



4-3 Ball screws for electrical injection molding machine

Unique design has achieved greater loading capacity, which contributes to longer service life.

- <Features>
- Very sophisticated internal design has greatly increased rated load compared with conventional standard ball screw series (2 to 4 times as great).
 - Excellent high-speed durability.
 - Wider range of variants are available.
 - Nut dynamic balance arrangement is possible (optional with rotary nut).
- <Applications>
- Injection shaft and mold clamping shaft on electric injection molding machine
 - Electric press machine
 - Electric drives on blow molding machine, vacuum molding machine, extrusion molding machine, and other molding machine.
 - Other applications that require higher load carrying capacity-for example, electric drive which has superseded previous hydraulic drive.



4-5 Ball screws for special environments

These screws can be used in a vacuum and dust-free chambers.

- <Features>
- All the parts, except the dustproof seal, are made of stainless steel.
 - Depending on the environment and operating conditions, the grease for the vacuum is enclosed or the surface treatment (the special PTFE coating or the Ag-ion-plating coating treatment) is processed.
 - The products can be used in the environment of low dust generation, in both clean air and vacuum, by processing the special PTFE coating treatment.



4-6 Hollow ball screws

Ball screws suitable to prevent the shaft from heat expansion. The temperature rise and expansion caused by heat generation is reduced by flowing the coolant through the hollow screw shaft.



4-4 Ball screws with high grade dustproof wiper seals

Ball screws with high grade dustproof ability up to 30 - 50 times (compared with other NTN products).

- <Features>
- Since fluoro plastics containing a special filler (BEAREE FL3000) are used for the seal material, heat generation by friction is low and products have superior wear resistance.
 - The ball screw is excellent at sealing not only for dust but also for coolant.
 - Compatible with previous products since the dimensions of the nuts are equal to previous models.

Contamination of screw axis in a dusty atmosphere

Ball screw specifications	Ball screw elements	Axis diameter : 40mm Lead : 10mm Ball diameter : 1/4" Turns : 2.5 turns 2 threads
	Seal type	Nut A : High grade dustproof wiper seals Nut B : Labyrinth seals
Test conditions	Dusty atmosphere	Containing the graphite 0.35 g (particle size:10 μm)
	Stroke range	100mm x 75000 cycles
	Lubricant	Grease (ALBANIA No.2)

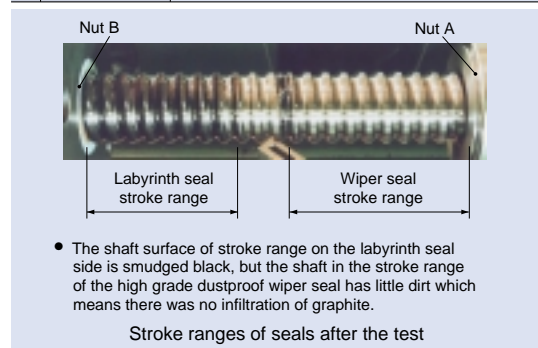

4-7 Plastic sliding screws

Miniature plastic sliding screws with screw outer diameters 4 - 12 mm.

- <Features>
- The screws use the BEAREE PI 5010 nuts (Thermoplastic polyimide plastics) and stainless steel screw shafts with excellent thermal resistance and corrosion resistance. These plastic sliding screws with low noise can be used in a wide range of environments where thermal resistance and corrosion resistance without lubrication are demanded.

Automation and Energy-Saving System Components

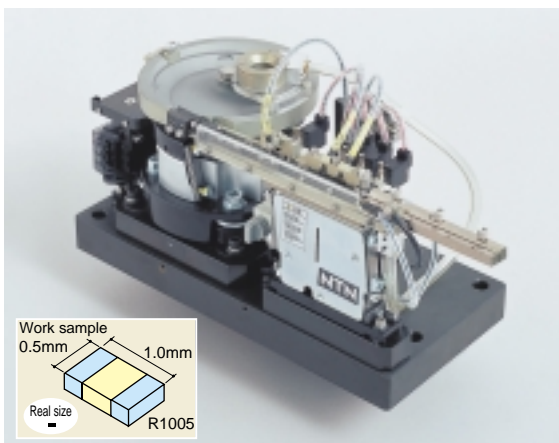

5-1.1 SMD feeder [for microchip resistors (R0603)]

Aligns R0603 (0.6 × 0.3 mm) chips with correct side facing upward, and supplies at a maximum speed of 2000 pieces a minute.

- <Features>
- Jamming of workpieces has been eliminated at the transfer section between the bowl and chute (greatly reduced down time).
 - High-speed, high-precision part feeding (supplies R0603 or R1005 at a maximum speed of 2000 pieces a minute).
 - Compact (floor space needed is less than 70% of the conventional model).

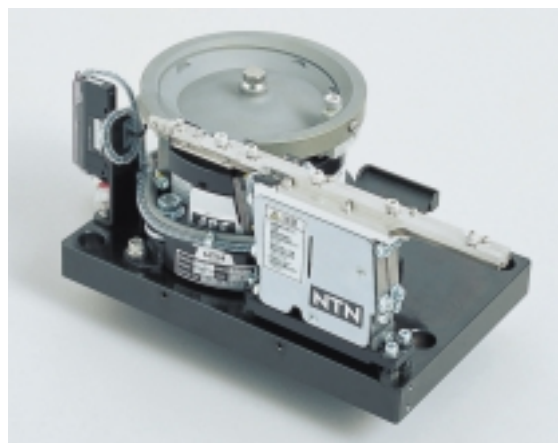

5-1.2 SMD feeder [for microchip capacitors (C0603)]

Supplies C0603 (0.6 × 0.3 mm) chips at a maximum speed of 3000 pieces a minute.

- <Features>
- Jamming of workpieces has been eliminated at the transfer section between the bowl and chute (greatly reduced down time).
 - High-speed, high-precision part feeding (supplies C0603 at a maximum speed of 3000 pieces a minute).
 - Air-free aligning system protects the workpieces against possible damage.



5-2.1 SMD controller (multi-function type)

Selective control, overflow control, and programmable I/O control.

- <Features>
- Correct-side alignment, correct-side selection, RUN/STOP by outside signal, overflow control, in-process air blow, run status detection, soft start, and other control features.
 - One controller unit is equipped with not only the vibration control circuit for high-frequency bowl feeder and high-frequency linear feeder but also a correct-side selection circuit for workpiece aligning.



5-2.2 SMD controller (standard type)

The compact controller can control both a high-frequency bowl feeder and a linear feeder.

- <Features>
- Variety of functions include overflow control, two-step speed control (bowl feeder), and soft start.
 - Frequency can be adjusted in steps of 0.1 Hz. The setting is indicated on the digital display.
 - High-frequency audible noise has been positively suppressed.

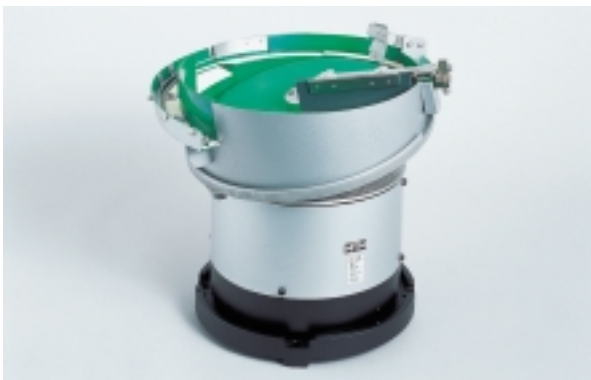

5-3 Non-slip composite feeder

The vibration bowl feeder has a built-in rotary disk. Retaining the correct-side aligning capability of a vibration feeder, this equipment can reliably feed workpieces contaminated with oil and offers low-noise operation.

- <Features>
- The rotary disk helps reliably feed difficult parts (such as pins or bolts contaminated with oil) which previous vibration feeder could not easily handle.
 - The vibration type aligning section can handle multi-shaped workpieces in the same manner as conventional feeders.

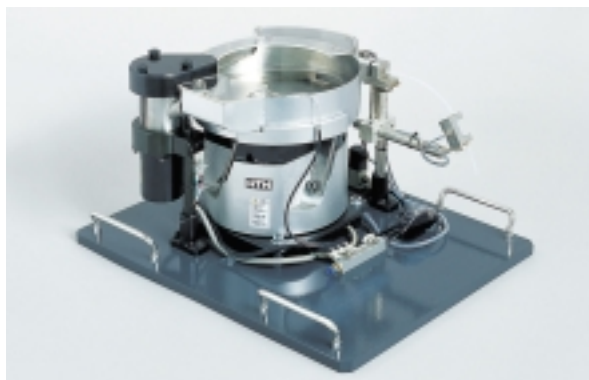

5-4 Spring separator feeder

This highly reliable feeder instantaneously untangles springs, and continuously feeds them. While untangling the springs with its pulsator (rotary blades), the self-contained feeder continuously feeds the workpieces at a higher speed.

- <Features>
- Persistently tangled springs are automatically returned to the separator. This arrangement allows a fully automatic assembly line to be designed.
 - Complete with an auto jamming release system.
 - High speed, low noise.



5-5 Space-saving type hopper

Improved part storing hopper for saving installation space. Newstoring/feeding hopper with the work storage tank mounted above the parts feeder.

- <Features>
- The unique structure which supports the hopper by a column saves installation space.
 - Easy maintenance. The hopper can be easily turned to shift from the feeding position for easy maintenance of parts feeder.

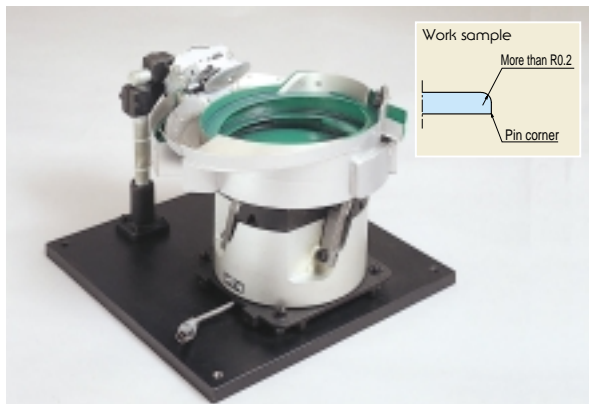

5-6 Aligning unit for micro-beveled parts

A unique classification mechanism aligns the front and reverse side of micro-beveled parts. NTN's unique mechanical aligning mechanism aligns the front and reverse side of plate parts, (with microscopic differences between the front and reverse side) that previous vibration feeders could not align perfectly.

- <Features>
- Completely mechanical classification mechanism aligns and feeds continuously at high accuracy.
 - Simplified bowl attachment and the simple classification mechanism provides high reliability.



5-7 Variable frequency controller (micro-computer type)

This digital variable frequency controller, the first micro-computer controlled controller in the parts feeder industry, has eliminated time-consuming adjustment for plate springs.

- <Features>
- High-precision: Frequency regulation within $\pm 0.01\%$. This is 20 times as accurate as our conventional controller.
 - Multi-functional: A multitude of functions only available from micro-computer controlled controller- the display indicates frequency and voltage in digital values, as well as multi-step speed setting function, to name a few.
 - One unit of the twin controller type can control both a bowl feeder and a linear feeder at a time.



5-8 I/O control unit

This control unit contains the programs for selecting parts within the bowl by sensor, for feeding parts in multiple rows, and for controlling the separator mechanism at the delivery. Using this equipment, a less experienced operator can control a parts feeding system by only selecting a program ID number and setting a timer.

- <Features>
- Can be used by simply selecting a program number and setting a timer.
 - Much reduced floor space requirement.
 - Low price, short lead time.



Clutches

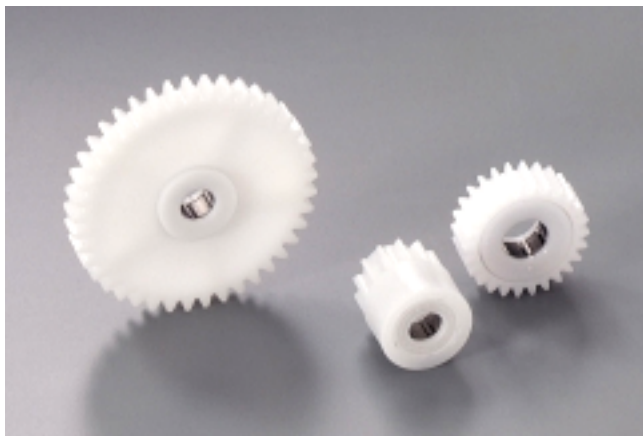

Component parts

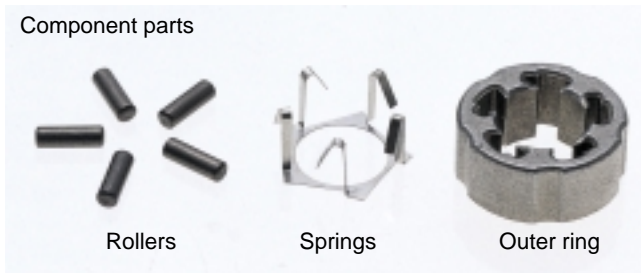

Rollers

Springs

Outer ring

Secured lock function and high temperature operation

6-1 Model NCZ, One-way clutch unit

Adoption of metal spring presents a secured lock function and possible operation under high temperature conditions (not higher than 140°C).

- <Features>
- External parts are plastic, as are previous models NCU, NCR, and are available in various shapes. Furthermore, the external parts of NCZ model are compatible with the external parts of NCR model.
 - Operative under high temperatures (up to 140°C) Please contact **NTN** Engineering when used at more than 100°C.
- <Applications>
- For copying machines and paper feeders of facsimile machines.

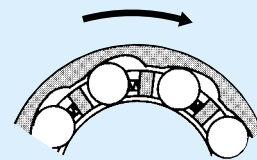

Clutch engaged

When the outer ring turns clockwise relative to the shaft, the spring forces the rollers to the seating positions on the outer ring cam face, thereby the wedge effect between the outer ring cam face and shaft drives the shaft.

(Spring: schematically illustrated)

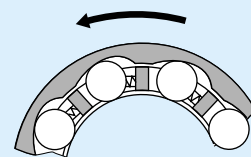

Clutch disengaged

When the outer ring turns counterclockwise relative to the shaft, the shaft turns clockwise relative to the outer ring, allowing the rollers to leave the outer ring cam face, thereby the outer ring freely rotates relative to the shaft.

(Spring: schematically illustrated)



6-2 Model NCUX, Narrow width one-way clutch unit

Reduced width dimension saves space. It contributes to a compact and light weight design by eliminating the cage, uses a metal spring and reduces the width dimension as much as possible.

<Features> • The unit is designed to be only 5 mm or so in width in comparison with previous models, which were more than 8 mm in width.

<Applications> • For paper feeders for copying and facsimile machines.



6-3 Combined products with one-way clutches

United deep groove ball bearings and one-way clutch.

<Features> • The small part functions as both bearing and one-way clutch.
• Simplified structure surround okay the one-way clutch.

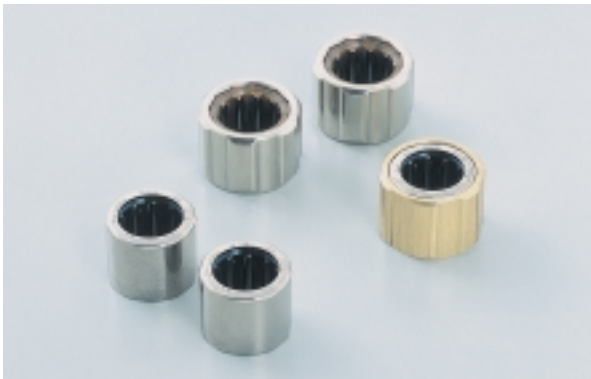

6-4 Special one-way clutches

Improved corrosion resistance and lower torque compared with standard shell type one-way clutches.

<Features> • Plated outer ring has enhanced corrosion resistance.
• Newly designed spring helps reduce slipping torque and ensure reliable locking.
• Protrusions on the outer ring positively lock the outer ring.

<Applications> • Reel for angling equipment.



6-5 Torque limiter units

These torque limiter units improve functionality of office automation equipment such as laser printers, copying machines and facsimile machines.

Utilizing the inner ring binding force by the coil spring, these units control the torque. They can incorporate external parts to form another unit.

<Features> • Being made of resin, the external parts can be readily customized with various forms and dimensions.
• Torque value can be arbitrarily set to a higher level.
• Torque can be stably maintained at a correct level. No lubrication is needed.

<Applications> • Office automation equipment such as laser printers, copying machines and facsimile machines.
• Tensioner mechanism for ink ribbon or printer sheet.

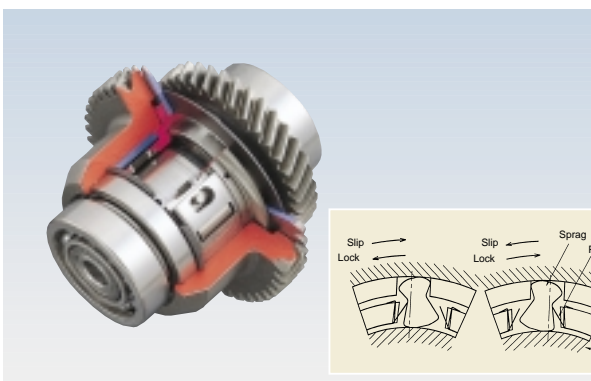

6-6 Two-way clutch unit

Two-way clutch automatically changes the clutch direction according to the rotating direction of input.

Two sprags with symmetrical left and right sections are held in the doubled inside and outside cages, then the clutch unit performs perfect clutching function according to the rotation direction of the torque input.

<Features> • Only one kind of sprag is used for both the regular and reverse rotation clamp.
• The clutch function for regular and reverse rotation is automatically and mechanically controlled according to the rotation direction of the input.



Fluoro-rubber group



Cat. No. 5100/E

NBR group



The sliding washers have rubber's elasticity as well as the fluoroplastic's sliding characteristics.

7-1 BEAREE ER3000 series, sliding rubber parts

For grades, the fluoro-rubber group (BEAREE ER3000/3600/3605) and NBR group (BEAREE ER3200) are prepared.

- <Features>
- Elastic body with low friction, excellent wear resistance, thermal resistance and chemical corrosion resistance.
- <Applications>
- For seals, O rings, wipers and bearings of automatic control units, semiconductor production equipment, food processing machines, home appliances and office machines.

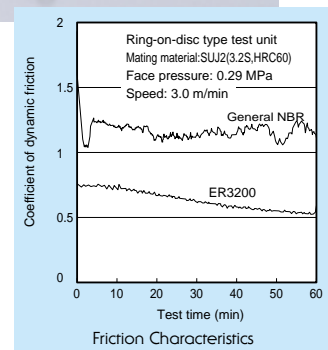

Cat. No. 5100/E

Polyimide plastics which can be injection molded, creating a wide range of design possibilities.

7-2 BEAREE PI5000 series of thermoplastic polyimide plastics

Thermoplastic polyimide plastics have excellent thermal resistance, mechanical and electrical characteristics, plus dimensions stability, and sliding properties.

<Major grades and applications>

- **BEAREE PI 5000 Series:** Sliding bearings, thrust bearings and piston rings.
- **BEAREE PI 5010:** Sliding bearings, thrust bearings.
- **BEAREE PI 5020:** Separating twines.
- **BEAREE PI 5033:** Gears, cages.
- **BEAREE PI 5040:** Gears, heat insulated sleeves, thrust bearings.

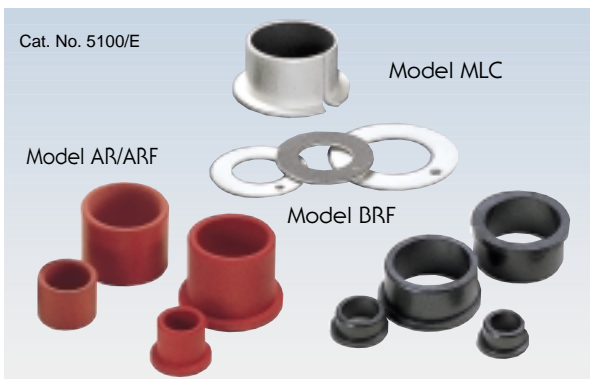

7-3 BEAREE sliding bearings standard products

The standard line of Bearee sliding bearings offers an economic advantage as well as special features and have been designed for a wide range of functions.

<Major types and features>

- MLC bearings: Bearings have excellent load capacity and can be operated without lubrication due to their three-layer structure of steel plate + copper group sintering + fluoroplastic containing a special filler.
- AR/ARF Type : Uses BEAREE FL3000 (Fluoroplastic containing a special filler) which is excellent for chemical resistance, weatherproof and stability against friction and wear.
- BRF Type: Uses BEAREE AS5000 (Special emplacement filled with fluoroplastic) which is an injection molding material with less wear to the soft mating material and high face pressure tolerance.



7-5 BEAREE seal rings/chip seals

Seal rings and chip seals of the injection mold type.

<Applications and Features>

- Seal ring: Used for automatic transmissions and compressors. Compared with fluoroplastic and cast iron seal rings, this ring has excellent oil leakage characteristics and wear resistance and can be used for soft mating materials such as aluminum die cast. BEAREE PK5300 and BEAREE PK5900 are used.
- Chip seal: Used for the end face seals of scroll type compressors. Does not deteriorate in refrigerant and freezer oil. Due to their molding properties and sliding characteristics, the seal can be used for soft mating materials. BEAREE AS5003 and BEAREE AS5004 are used.



7-7 BEARPHITE SG

Sintered bearings impregnating the special grease.

- <Features>
- Low temperature torque is small, and the rotation torque is stable regardless of the length of time.
 - Torque change is low regardless of the number of rotation changes.
 - Low grease leakage.
 - A long operating life can be expected under high temperature.

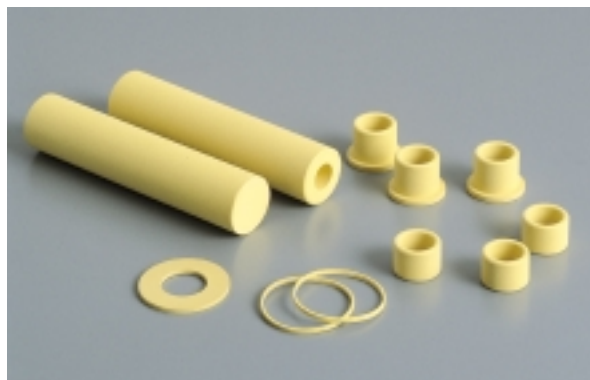

7-4 Sliding bearing materials for food processing machines, BEAREE FL3642

BEAREE EL3642 is designed for use in water and in air without lubrication, such as in food processing machines. Major material is fluoroplastics, which is a superior material in thermal resistance, wear resistance and chemical resistance.

<Features>

- Meets the standards for plastic tools, or vessels and package materials in the Japan Food Sanitation Act.
- The friction coefficient is small in water or dry conditions, resulting in low wear.
- Damages to the soft mating material of stainless steel and aluminum are minimal.



7-6 Oil-impregnated sintered bearing units for high performance small motors

High-precision, long-life bearing units incorporating hydrodynamic BEARPHITE and TWIN BEARPHITE.

<Features>

- hydrodynamic BEARPHITE
 - Dynamic pressure effect helps realize high running accuracy at a higher speed range.
 - Herringbone type dynamic pressure groove greatly enhances oil film formation and rigidity.
- TWIN BEARPHITE
 - Twin type bearing helps reduce torque.
 - Combining two bearings into one unit can improve concentricity.

<Application>

- DVD-ROM/RAM, CD-R/RW, CD-ROM, MD, axial fan, polygon scanner motor.

NTN CATALOG LIST

CATALOG TITLES	CATALOG No.
BALL AND ROLLER BEARINGS	
Ball and Roller Bearings	2202/C/E/F/D/I/K/S/T/TC
Large Bearings	2250/E
Plastic Cages for Rolling Element Bearings	3012/E
Miniature and Extra Small Ball Bearings	3013/E
Miniature Molded Rubber Bearings	3014/E
Vacuum Bearings	3016/E
Care and Maintenance of Bearings	3017/E/S
Ultra-Clean Bearings	3018/E
HL Bearings	3020/E
Bearings with Solid Grease	3022/E/S
Large Size, Long Operating Life Bearing-EA type	3024/E
Tapered Roller Bearings ECO-Top	3026/E/S
Self-Aligning Spherical Roller Bearings LH Series	3027/E/S
Super Slim Ball Bearings	3101/E
Ceramic Ball / Angular-Contact Bearings	3203/E
Insulated Bearings-Resin Coated Type	3204/E
Cross Roller Thrust Bearings	3501/E
Type E Spherical Roller Bearings	3701/E
Sealed Self-Aligning Roller Bearings-WA Type	3702/E
Aerospace Bearings	8102/E
Precision Rolling Bearings for Machine Tools	8401/E
NEEDLE ROLLER BEARINGS	
Needle Roller Bearings	2300/E/I
Miniature Cam Followers	3601/E
CONSTANT VELOCITY JOINTS	
Constant Velocity Joints for Automobiles	5601/JE
TRI-Ball Joint / Constant Velocity Joints	5602/E
Constant Velocity Joints for Industrial Applications	5603/E
BEARING UNITS	
Bearing Units	2400/E/I/S
Bearing Units with Ductile Cast Iron Housing	3901/E
Bearing Units Steel Series	3902/E
Bearing Units Stainless Series	3903/E
Bearing Units Plastic Housing Series	3904/E
Triple-Sealed Bearings for Bearing Units	3905/E

CATALOG TITLES	CATALOG No.
PLUMMER BLOCKS	
Plummer Blocks	2500E/S
PRECISION BALL SCREWS	
Precision Ball Bearings	6000/E
Rolled Ball Screws	6206/E
PARTS FEEDER	
Parts Feeder	7018/E
NTN Parts Feeder with Standard Attachments (for Bolts or Washer)	7016/E
CLUTCHES	
One-way Clutches (Overrunning Clutches)	6402/E
PLAIN BEARINGS	
"BEAREE" NTN Engineering Plastics	5100/E
NTN "BEARPHITE" Oil Impregnated Sintered Bearings	5202/E
Spherical Plain Bearings	5301/E
HANDBOOK	
Bearing Units Handbook	9011/E/S
Rolling Bearings Handbook	9012/E
Needle Roller Bearings Handbook	9013/E
GUIDE BOOK	
Parts Feeder Guide Book	7019/E
Automotive Products Guide Book	8021/E/D/F
New Products Guide	9208/E
Food Machinery Component Guide	9209/E
ELECTRONIC CATALOG	
NTN Electronic Catalog (CD-ROM for Windows)	7903/E
NTN Autoparts Catalog (CD-ROM for Windows)	7905/E
Reference Kit Program -Bearing Interchange- (CD-ROM for Windows)	7907/E
OTHERS	
Adapters Locknuts and Lockwasher-Inch series	2612/E
Steel Balls for Bearing	4202/E
Bearing Handling	9103/E/P/S

C:Chinese E:English F:French D:Germany I:Italian
K:Korean S:Spanish T:Thai TC: Taipei Chinese

Note : The above are basic numbers. Renewal of the suffix by a revision.



**WORLD NETWORK
R&D CENTERS**

EUROPE

NTN BEARINGS (UK) LTD.

1 Head Office (LICHFIELD)

NTN WÄLZLAGER (EUROPA) GMBH

1 Hauptverwaltung NORDRHEIN-WESTFALEN
Niederlassung NORDRHEIN-WESTFALEN

2 Niederlassung STUTTGART

3 Niederlassung MÜNCHEN

4 Verkaufs-und Ingenieurbüro BAD HOMBURG

5 Verkaufs-und Ingenieurbüro CHEMNITZ

6 Verkaufs-und Ingenieurbüro HAMBURG

7 Filiale in ITALIA

NTN KUGELLAGERFABRIK (DEUTSCHLAND) G.m.b.H.

1 METTMANN PLANT

NTN FRANCE S.A.

1 Head Office (HAGUENAU)

2 Agence de PARIS

3 Agence de LYON

1 Société Nouvelle de Transmissions du Mans

2 NTN Transmissions Europe

JAPAN

NTN corporation

- 1 Head Office (OSAKA)
- 2 TOKYO Branch
- 3 KANTO Automotive Branch
- 4 TOKAI Automotive Branch
- 5 NAGOYA Branch
- 6 OSAKA Branch
- 7 KYUSYU Branch
- 8 TOHOKU Branch
- 9 HIROSHIMA Branch

1 KUWANA Works

2 IWATA Works

3 OKAYAMA Works

4 TAKARAZUKA Works

5 NAGANO Works

AUSTRALIA

NTN-CBC(AUSTRALIA) PTY. LTD.

1 Head Office (KINGSGROVE)

1 UNIDRIVE PTY. LTD.

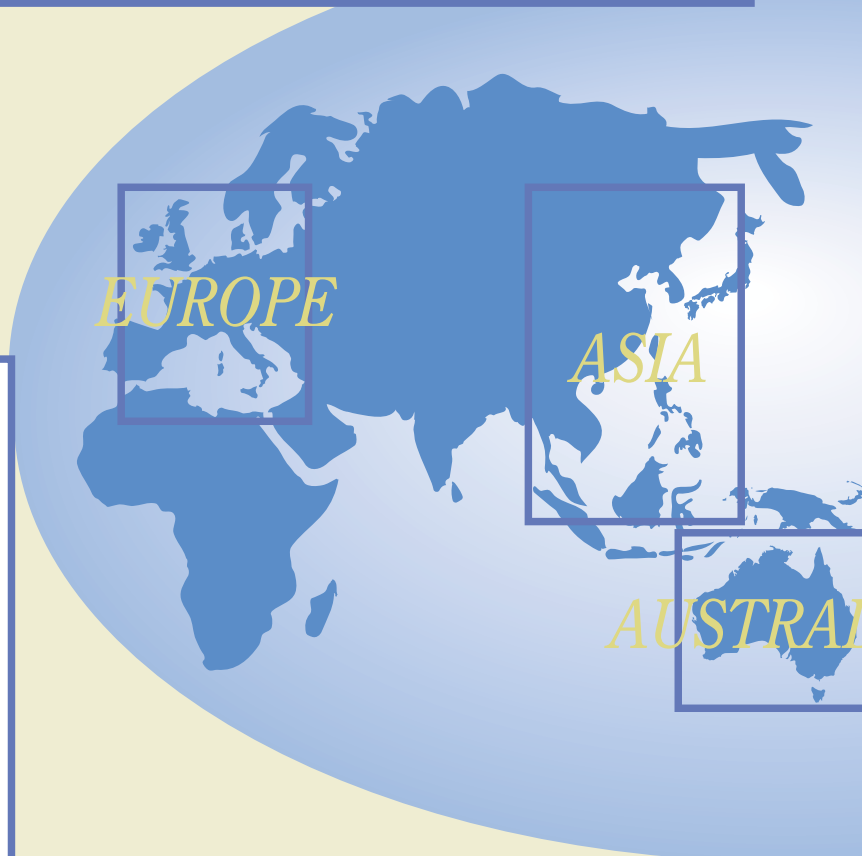

ASIA



NORTH AMERICA



SOUTH AMERICA



NORTH AMERICA

SOUTH AMERICA



RESEARCH & DEVELOPMENT-MECHATRONICS/RESEARCH & DEVELOPMENT-AUTOMOTIVE PRODUCTS Iwata-shi, Shizuoka Prefecture, Japan

In this laboratory, NTN corporation promotes the research and development of super high speed rotation, electronic controls, special machining and constant velocity universal joints and various clutches in the automobile related fields. The laboratory exists as the frontier for new NTN products and new techniques ranging from precision-elements technologies to system development.



KUWANA ENGINEERING NEW CENTER

Kuwana-shi, Mie Prefecture, Japan

The BEARING ENGINEERING LABORATORY and the BEARING ENGINEERING DEPARTMENT are located in this laboratory. These departments lead the research and development of bearings and their related technical fields.



Top-ranking anechoic chamber in the world



IWATA ENGINEERING NEW CENTER Iwata-shi, Shizuoka Prefecture, Japan

The AUTOMOTIVE PRODUCT ENGINEERING DEPARTMENT, C.V.JOINT ENGINEERING DEPARTMENT, NEEDLE ROLLER BEARING ENGINEERING DEPARTMENT, PRECISION EQUIPMENT ENGINEERING DEPARTMENT are located in this laboratory. These departments develop many compound products based on technologies used to produce bearings.



**RESEARCH & DEVELOPMENT
-MANUFACTURING ENGINEERING**

Iwata-shi, Shizuoka Prefecture, Japan

The DEPARTMENT is a leader in innovative manufacturing techniques—from the fields of research and development to the production lines — all put to use by NTN corporation.



NTN TECHNICAL CENTER (U.S.A.) INC. Michigan, USA.

As a center of technical development by NTN in the United States, the CENTER promotes research and development in many fields based on bearing engineering while working with other institutes in the USA.